

AS SHOWN @ DOORS

OPP. HAND @ DOORS

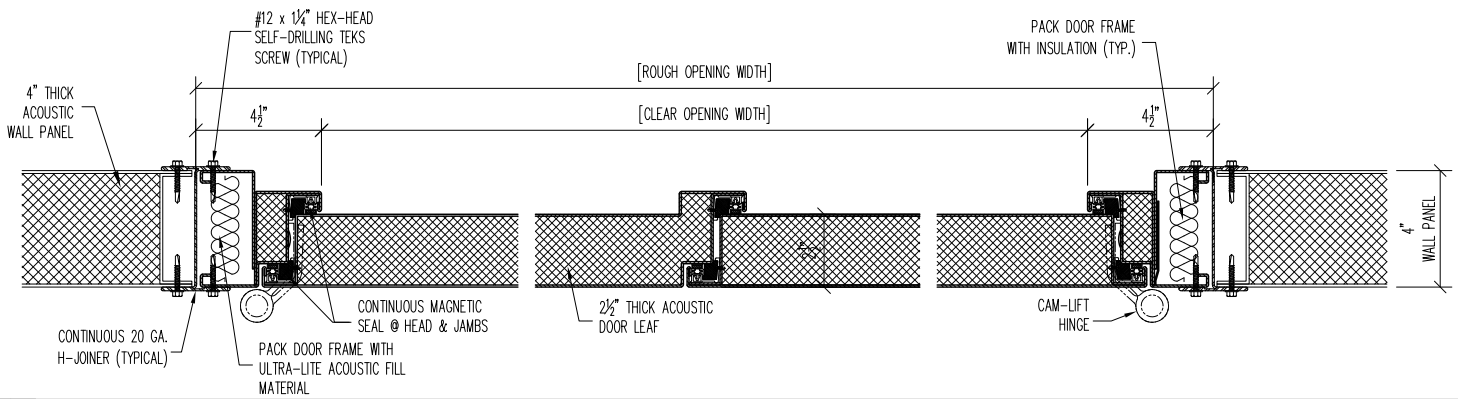

1 JAMB DETAIL

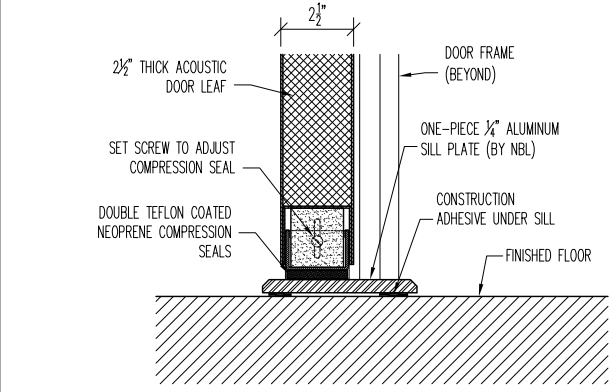
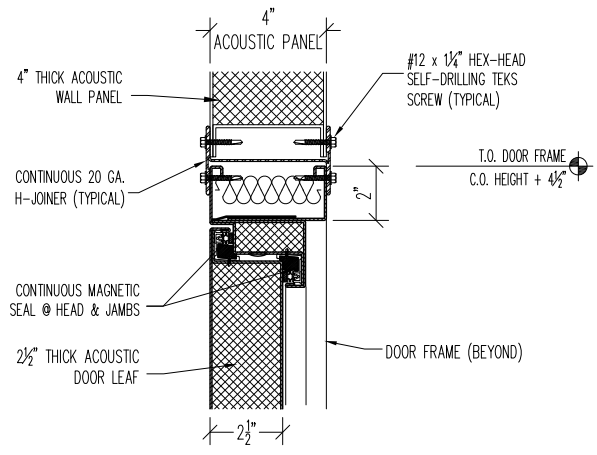

2 HEAD DETAIL

3 SILL DETAIL

**STC-52 DL-DOOR
TYPICAL - TYPE 'B'
INSTALL DETAILS**

PROJECT:		TYPE:	
SUBMITTED BY:	DATE:	ISSUE:	
APPROVED BY:	DATE:	PROJECT No.:	
PROJ. MGR.	SHEET:		

NOISE BARRIERS
401 AIRPORT DRIVE
NORTH AURORA, IL 60532
Phone: (847) 843-0500
Fax: (847) 843-0501
www.noisebarriers.com