

AS SHOWN @ DOORS

OPP. HAND @ DOORS

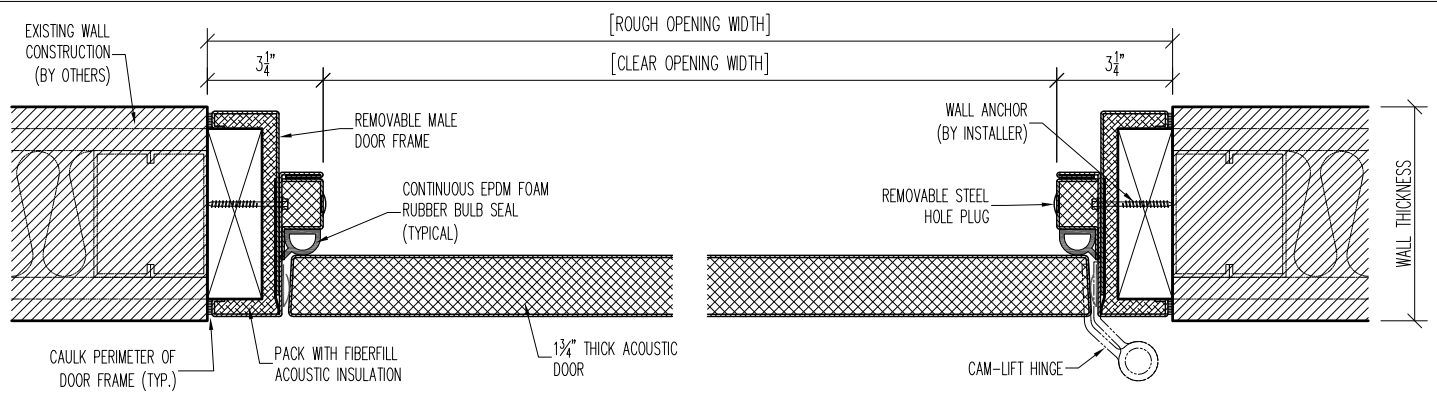

1 JAMB DETAIL

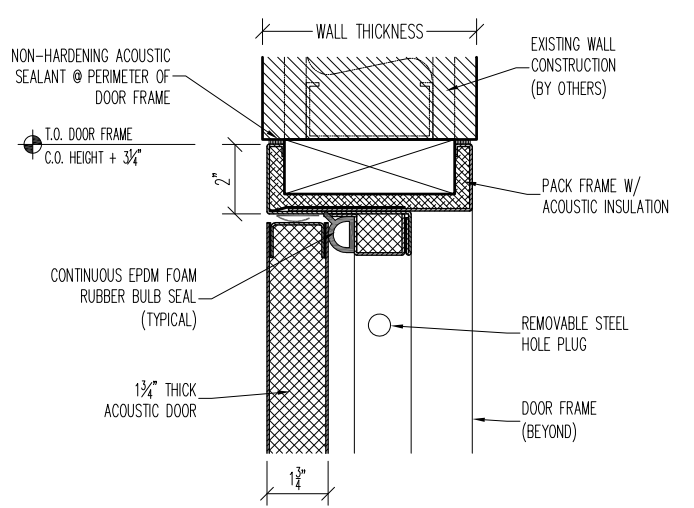

3 SILL DETAIL

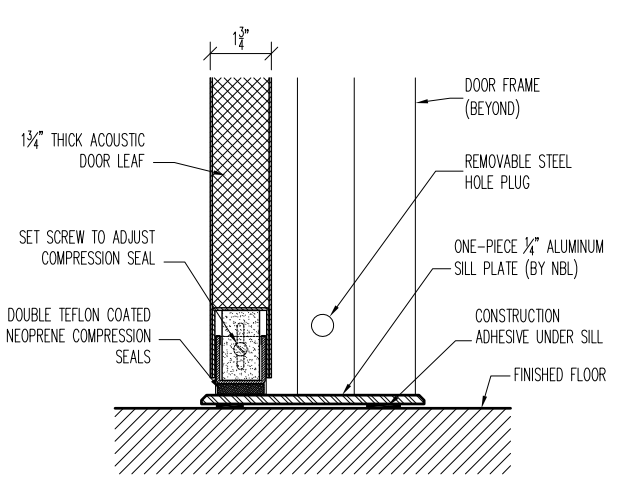

2 HEAD DETAIL

**STC-46 DOOR
TYPE 'B'
INSTALLATION DETAILS**

PROJECT:		TYPE:
SUBMITTED BY:	DATE:	ISSUE:
APPROVED BY:	DATE:	PROJECT No.:
PROJ. MGR.	SHEET:	

NOISE BARRIERS
 401 AIRPORT DRIVE
 NORTH AURORA, IL 60532
 Phone: (847) 843-0500
 Fax: (847) 843-0501
 www.noisebarriers.com