

PROJECT NAME: _____ CUSTOMER: _____

APPLICATION: INTERIOR EXTERIOR FINISH: _____ NB JOB #: _____

DOUBLE-LEAF DOOR SUBMITTAL

DOOR No.	DOOR SWING (ACTIVE LEAF)	WINDOW OPTION		INSTALLATION OPTION	CLEAR OPENING WIDTH	CLEAR OPENING HEIGHT	ROUGH OPENING WIDTH	ROUGH OPENING HEIGHT	WALL THICKNESS
		ACTIVE	INACTIVE						

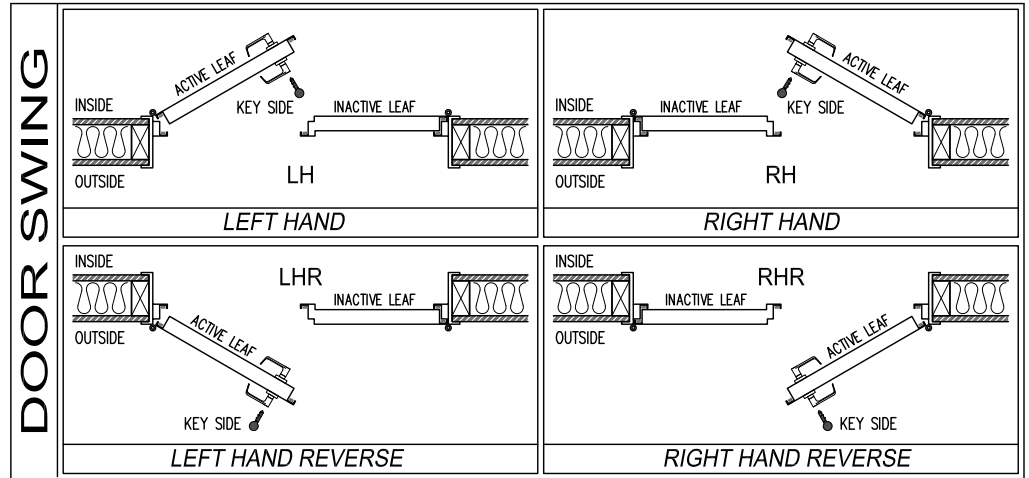
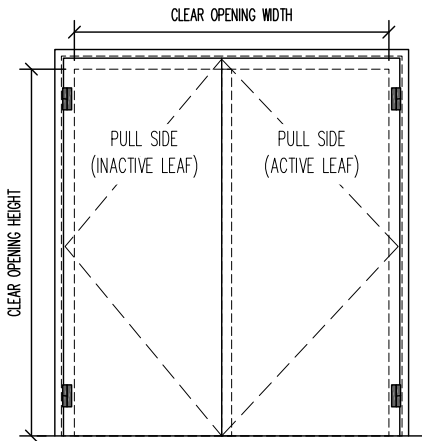

WINDOW OPTIONS

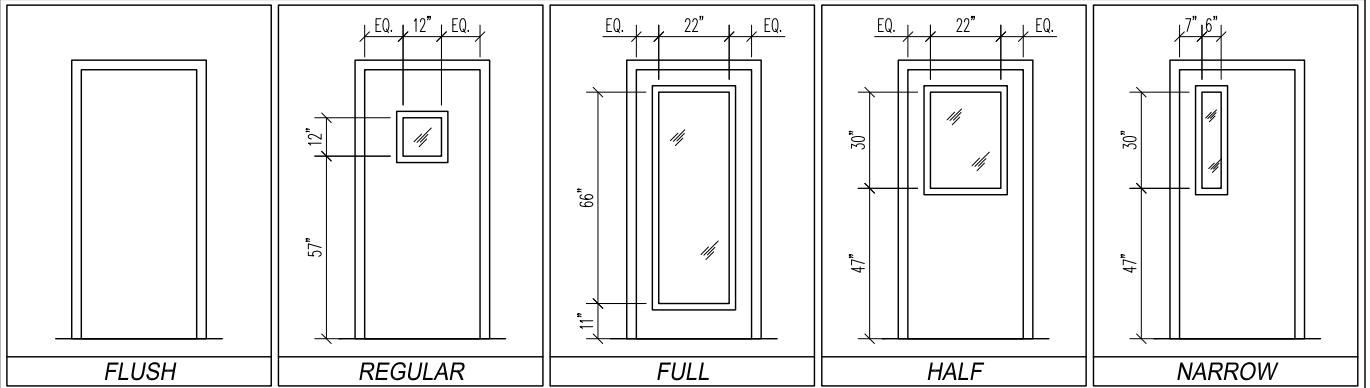

INSTALLATION OPTION

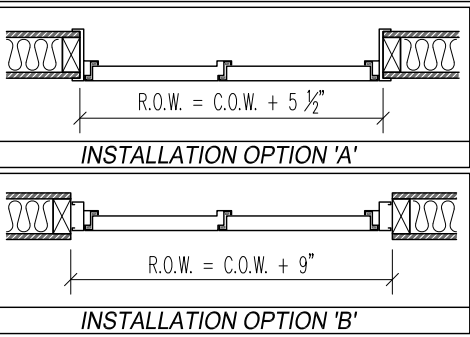

HARDWARE SCHEDULE

HINGES	NBL-CLH-100 OFFSET CAM-LIFTING HINGES (FINISH: DULL SILVER)	QTY.
DOOR BOTTOM	MFG. STANDARD TEFLON COATED COMPRESSION SEAL	QTY. 1
HD/JMB/ASTRAGAL SEALS	MFG. STANDARD DOUBLE MAGNETIC SEALS	as req'd
THRESHOLD	ONE-PIECE 1/4" ALUMINUM SILL PLATE	QTY. 1

NOTES: _____

STC-56
DOUBLE-LEAF DOOR
SPECIFICATIONS

PROJECT:		TYPE:
SUBMITTED BY:	DATE:	ISSUE:
APPROVED BY:	DATE:	PROJECT No.:
PROJ. MGR.	SHEET:	

NOISE BARRIERS
401 AIRPORT DRIVE
NORTH AURORA, IL 60532
Phone: (847) 843-0500
Fax: (847) 843-0501
www.noisebarriers.com