

PROJECT NAME: _____ CUSTOMER: _____

APPLICATION: INTERIOR EXTERIOR FINISH: _____ NB JOB #: _____

SINGLE-LEAF DOOR SUBMITTAL

DOOR No.	DOOR SWING	WINDOW OPTION	INSTALLATION OPTION	CLEAR OPENING WIDTH	CLEAR OPENING HEIGHT	ROUGH OPENING WIDTH	ROUGH OPENING HEIGHT	WALL THICKNESS

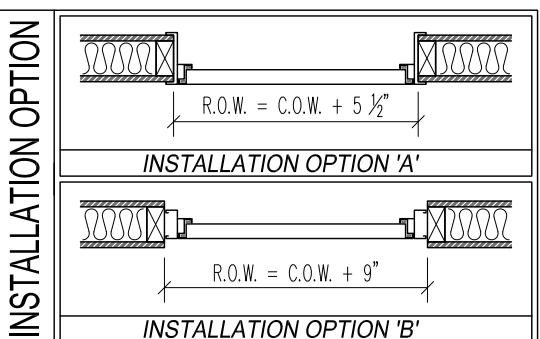
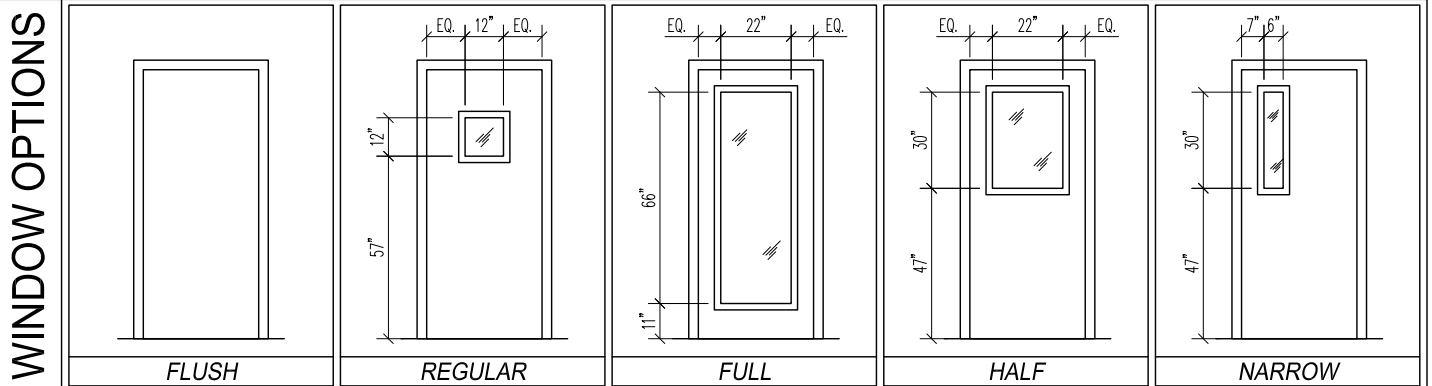
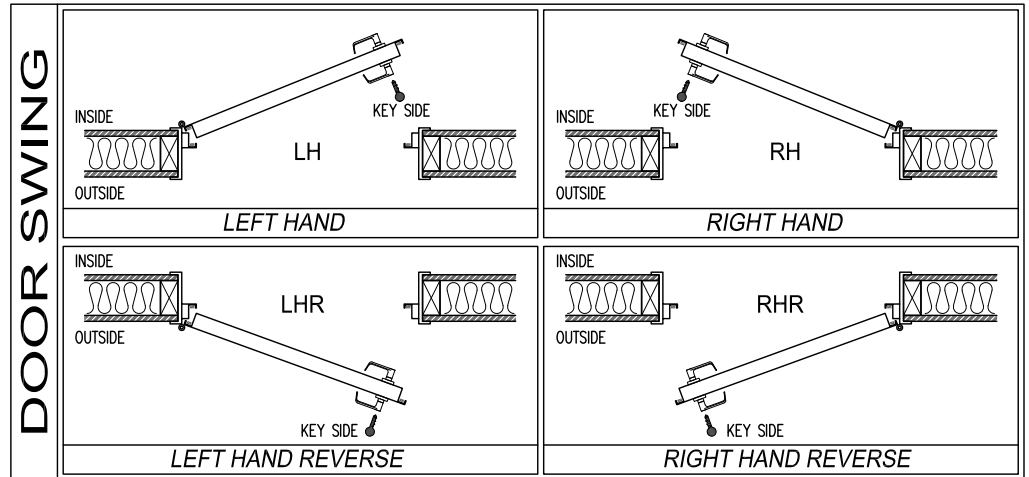
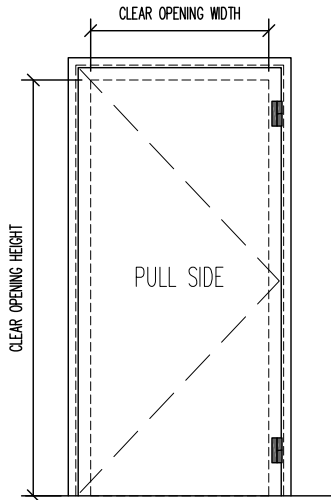

HARDWARE SCHEDULE		
HINGES	NBL-CLH-100 OFFSET CAM-LIFTING HINGES (FINISH: DULL SILVER)	QTY.
DOOR BOTTOM	MFG. STANDARD TEFLON COATED COMPRESSION SEAL	QTY. 1
HD/JMB/SEALS	MFG. STANDARD DOUBLE MAGNETIC SEALS	as req'd
THRESHOLD	ONE-PIECE 1/4" ALUMINUM SILL PLATE	QTY. 1

NOTES: _____

<h3>STC-54</h3> <h2>SINGLE-LEAF DOOR SPECIFICATIONS</h2>	PROJECT:	TYPE:	
	SUBMITTED BY:	DATE:	ISSUE:
	APPROVED BY:	DATE:	PROJECT No.:
	PROJ. MGR.	SHEET:	

NOISE BARRIERS
 401 AIRPORT DRIVE
 NORTH AURORA, IL 60532
 Phone: (847) 843-0500
 Fax: (847) 843-0501
www.noisebarriers.com