

AS SHOWN @ DOORS		
OPP. HAND @ DOORS		

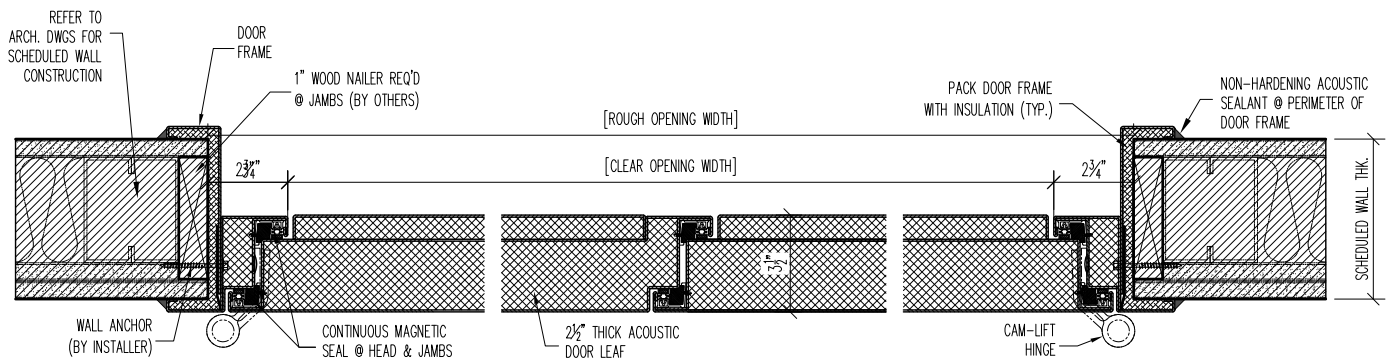

1 JAMB DETAIL

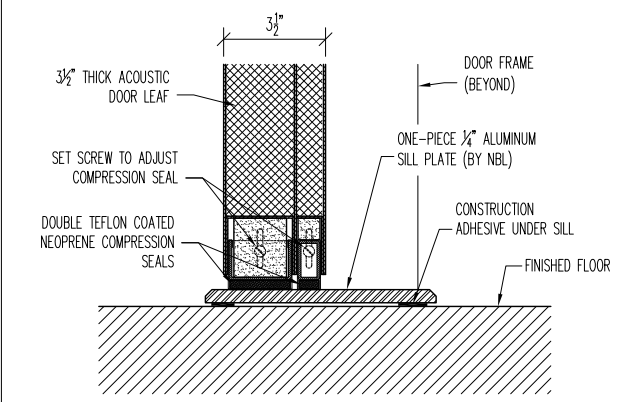
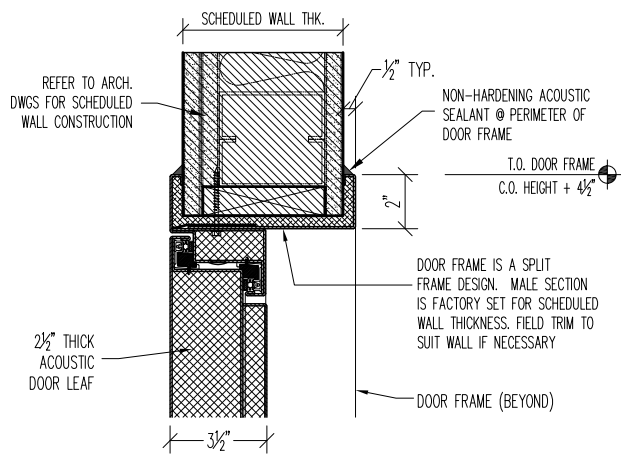

2 HEAD DETAIL

3 SILL DETAIL

**STC-56 DL-DOOR
TYPICAL - TYPE 'A'
INSTALL DETAILS**

PROJECT:		TYPE:
SUBMITTED BY:	DATE:	ISSUE:
APPROVED BY:	DATE:	PROJECT No.:
PROJ. MGR.	SHEET:	

NOISE BARRIERS
 401 AIRPORT DRIVE
 NORTH AURORA, IL 60532
 Phone: (847) 843-0500
 Fax: (847) 843-0501
 www.noisebarriers.com