

AS SHOWN @ DOORS		
OPP. HAND @ DOORS		

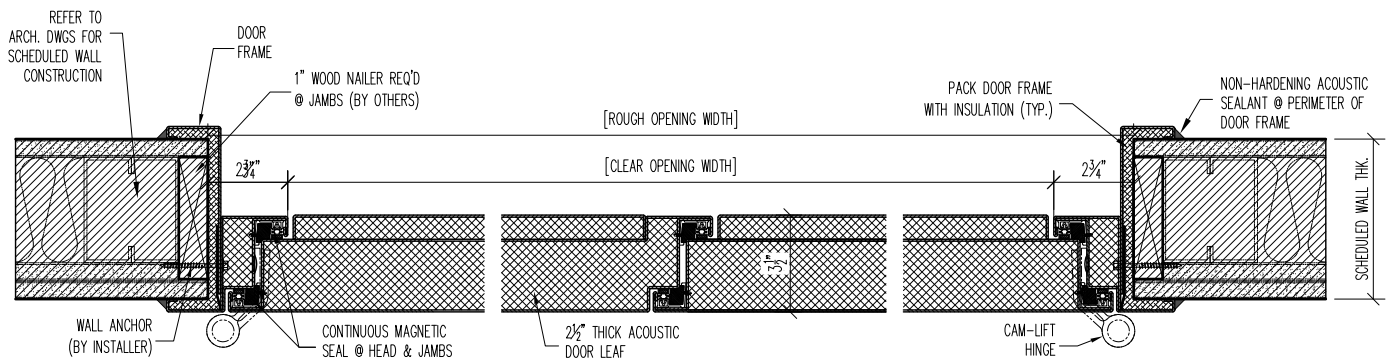

### 1 JAMB DETAIL

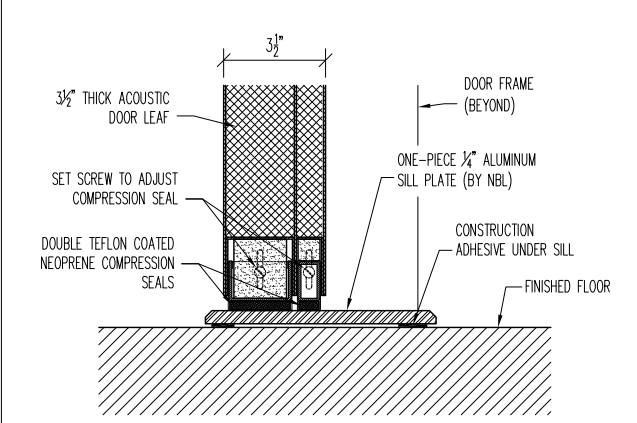
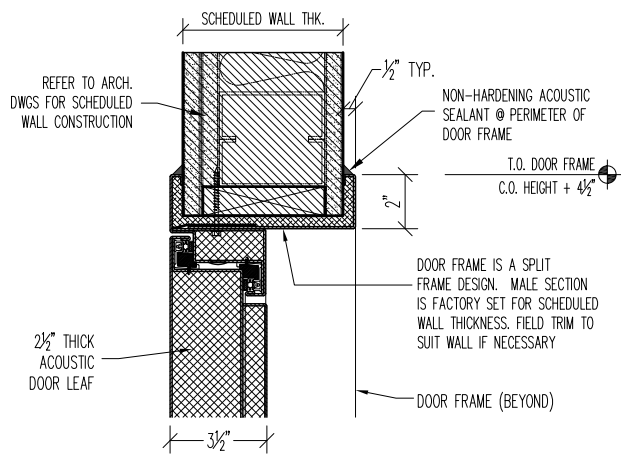

### 2 HEAD DETAIL

### 3 SILL DETAIL

**STC-54 DL-DOOR  
TYPICAL - TYPE 'A'  
INSTALL DETAILS**

PROJECT:		TYPE:
SUBMITTED BY:	DATE:	ISSUE:
APPROVED BY:	DATE:	PROJECT No.:
PROJ. MGR.	SHEET:	

**NOISE BARRIERS**  
 401 AIRPORT DRIVE  
 NORTH AURORA, IL 60532  
 Phone: (847) 843-0500  
 Fax: (847) 843-0501  
 www.noisebarriers.com