

AS SHOWN @ DOORS

OPP. HAND @ DOORS

1 JAMB DETAIL

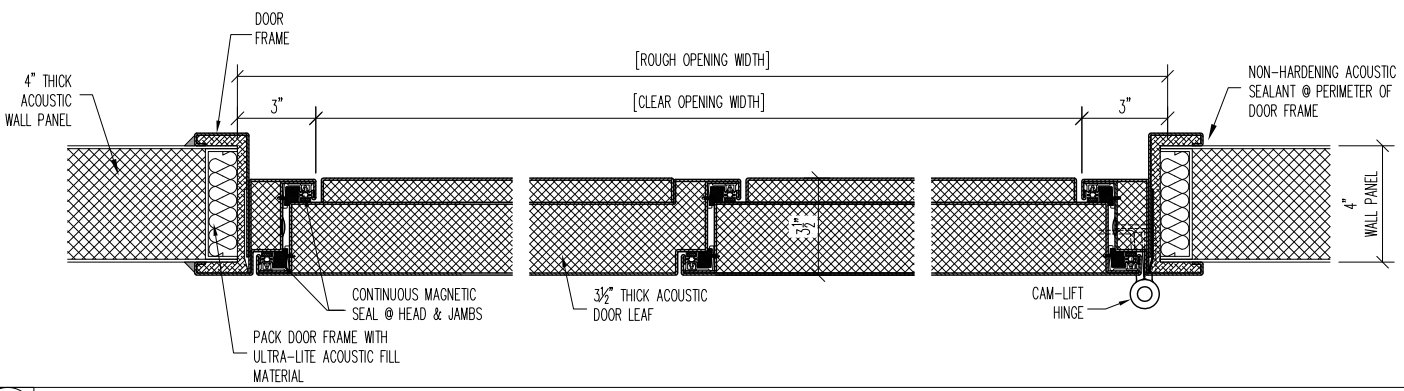
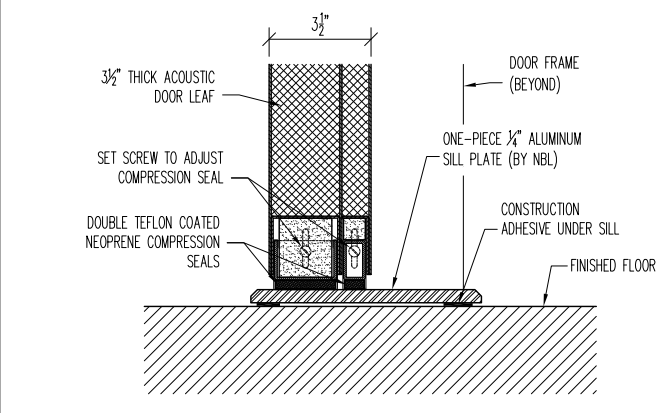
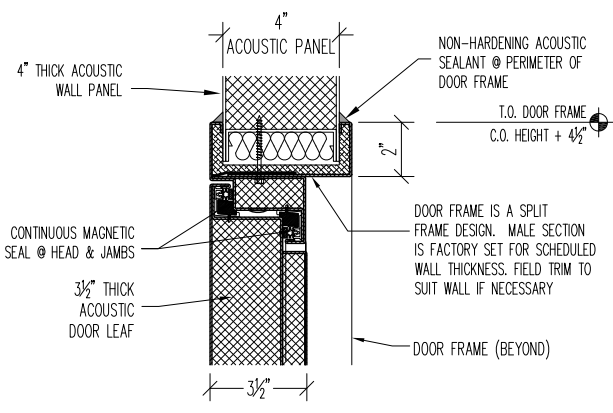

2 HEAD DETAIL

3 SILL DETAIL

STC-54 DL-DOOR  
TYPICAL  
INSTALL DETAILS

PROJECT:		TYPE:	
SUBMITTED BY:	DATE:	ISSUE:	
APPROVED BY:	DATE:	PROJECT No.:	
PROJ. MGR.	SHEET:		

Noise Barriers, LLC  
2001 Kelley Court  
Libertyville, IL 60048  
Phone: (847) 843-0500  
Fax: (847) 843-0501  
www.noisebarriers.com