

JAMB DETAIL

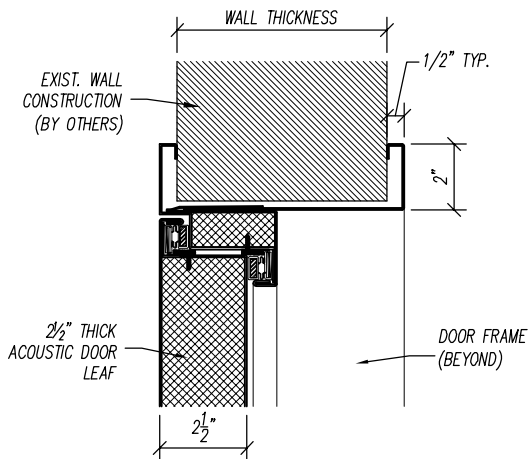

HEAD DETAIL

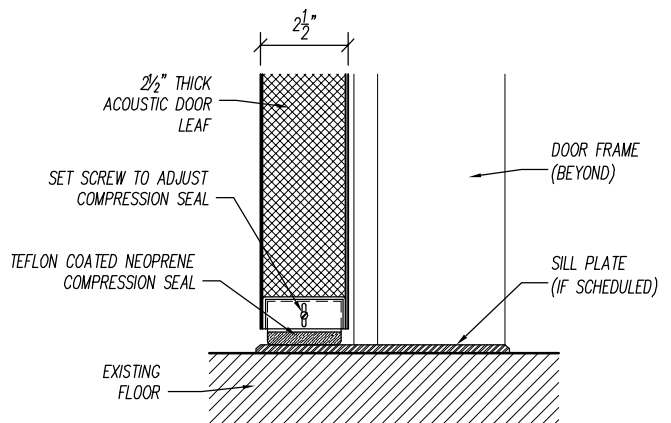

SILL DETAIL

STC-45 SL-DOOR  
INSTALLATION  
OPTION: A

PROJECT:		TYPE:	
SUBMITTED BY:	DATE:	ISSUE:	
APPROVED BY:	DATE:	DRAWING No.:	
	SHEET:		

**Noise Barriers, LLC**  
2001 Kelley Court  
Libertyville, IL 60048  
Phone: 847-843-0500  
Fax: 847-843-0501  
www.noisebarriers.com