

JAMB DETAIL

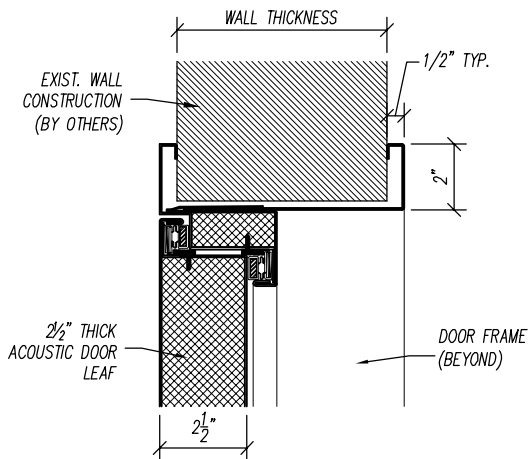

HEAD DETAIL

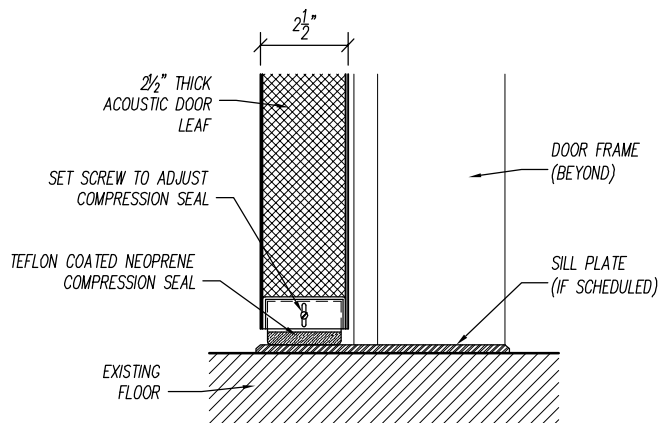

SILL DETAIL

STC-50 SL-DOOR
INSTALLATION
OPTION: A

PROJECT:		TYPE:
SUBMITTED BY:	DATE:	ISSUE:
APPROVED BY:	DATE:	DRAWING No.:
SHEET:		

Noise Barriers, LLC
2001 Kelley Court
Libertyville, IL 60048
Phone: 847-843-0500
Fax: 847-843-0501
www.noisebarriers.com