

JAMB DETAIL

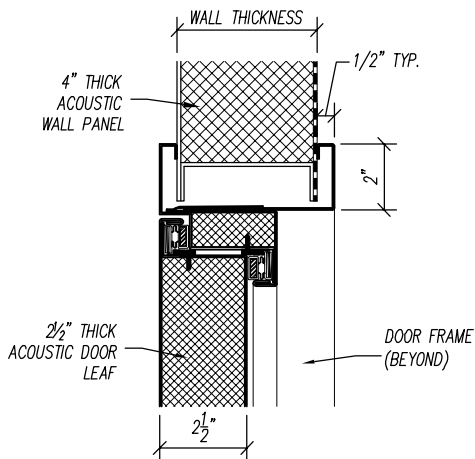

HEAD DETAIL

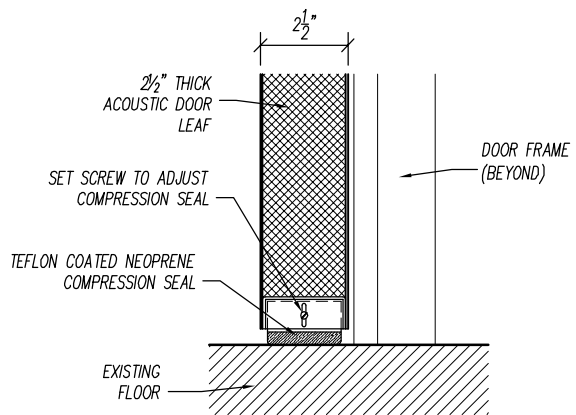

SILL DETAIL

STC-50 SL-DOOR
 INSTALLATION OPTION: A
 DETAIL @ 4" THICK
 ACOUSTIC PANEL

PROJECT:		TYPE:
SUBMITTED BY:	DATE:	ISSUE:
APPROVED BY:	DATE:	DRAWING No.:
SHEET:		

Noise Barriers, LLC
 2001 Kelley Court
 Libertyville, IL 60048
 Phone: 847-843-0500
 Fax: 847-843-0501
 www.noisebarriers.com