

JAMB DETAIL

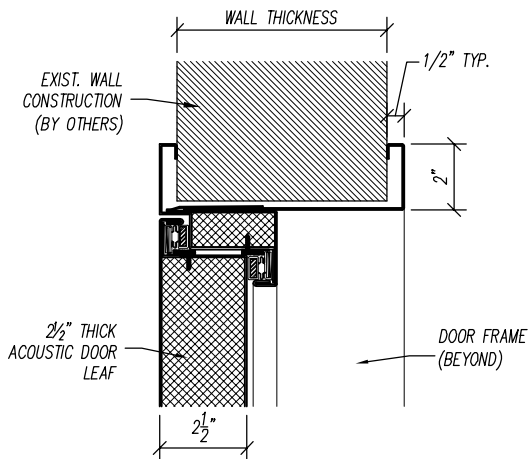

HEAD DETAIL

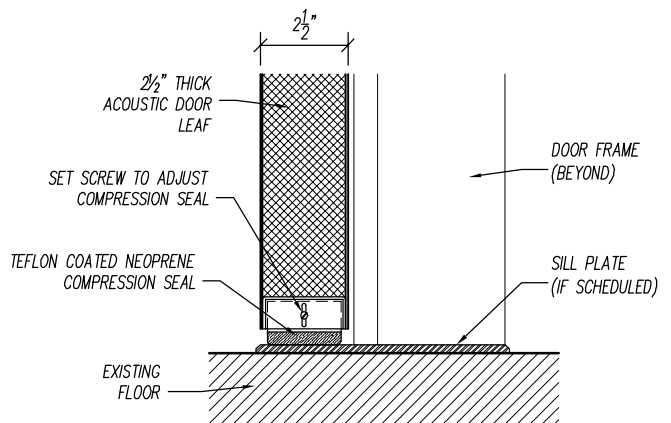

SILL DETAIL

STC-45 SL-DOOR  
INSTALLATION  
OPTION: A

PROJECT:		TYPE:
SUBMITTED BY:	DATE:	ISSUE:
APPROVED BY:	DATE:	DRAWING No.:
SHEET:		

**Noise Barriers, LLC**  
1207 Remington Rd., Suite E  
Schaumburg, IL 60173  
Phone: (847) 843-0500  
Fax: (847) 843-0501  
www.noisebarriers.com